

Service
Service
Service



37 532A

For repair information of the cassette mechanism see Service Manual of "Recorders tape deck SE3/5555"

Service Manual

SPECIFICATION	Nominal value	Typical value
General		
Mains voltage	: 220 V ~ Service solution for 110 V - 240 V	: 220 V ~ Service solution for 110 V - 240 V
Mains frequency	: 50-60 Hz	: 50-60 Hz
Power consumption	: 13 W max.	: 13 W max.
Dimensions (WxHxD)	: 420x104x234 mm	: 420x104x234 mm
Weight	: 4 kg	: 4 kg
Cassette recorder		
Cassette system	: compact cassette	: compact cassette
Number of tracks	: 2x2 (stereo)	: 2x2 (stereo)
Tape speed	: 4.76 cm/sec	: 4.76 cm/sec
Speed deviation	: ±1.5% (DIN)	: ±1.3% (DIN)
Wow and flutter (weighted)	: ≤0.15% (DIN)	: 0.13% (DIN) ≤0.04% (NAB)
Fast-wind time (C60)	: ≤85 sec	: ≤85 sec
Bias and erase frequency	: 85 kHz ± 5%	: 85 kHz ± 5%
Frequency range	: DIN45500:	: IEC: NAB:
Metal	: 30-14,000 Hz	: 30-16,000 Hz 30-17,000 Hz
Chromium	: 30-13,000 Hz	: 30-15,000 Hz 30-16,000 Hz
Normal	: 30-12,500 Hz	: 30-15,000 Hz 30-16,000 Hz
Signal/noise (without dolby)	: DIN45500:	: DIN45500: NAB:
Metal	: ≥54 dB	: 57 dB 59 dB
Chromium	: ≥56 dB	: 57 dB 59 dB
Normal	: ≥54 dB	: 55 dB 57 dB
Improvement with dolby B	: ≥ 8.5 dB (CCIR)	: 10 dB (at 5 kHz)
Distortion (K3)	: ≤3%	: ≤2%
Input sensitivity		
Microphone	: 0.56 mV at 2 kΩ	: 0.56 mV at 2 kΩ
Line input cinch	: 100 mV at 50 kΩ	: 100 mV at 50 kΩ
Outputs		
Line output	: ≥0.58 V/Z ₀ <2.2 kΩ	: ≥0.58 V/Z ₀ <2.2 kΩ
Headphones	: 350 mV at 600 Ω	: 350 mV at 600 Ω
Headphones impedance	: 8-600 Ω	: 8-600 Ω

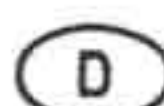

Controls and connections

Fig. 1 and 2

- | | | | | | |
|----|-------------------------------|-------|----|-------------------------|--|
| 1 | Mains on/off switch | SK0 | 12 | Pause button | |
| 2 | Eject button | | 13 | Recording level control | |
| 3 | Cassette holder | | 14 | Pause indicator | |
| 4 | Counter | | 15 | Rec. indicator | |
| 5 | Zero-reset button for counter | | 16 | Dolby NR on/off switch | |
| 6 | Recording level indicators | U1001 | 17 | Tape select buttons | |
| 7 | Record button | SK54 | 18 | Microphone socket | |
| 8 | Rewind button | SK55 | 19 | Headphone socket | |
| 9 | Stop button | SK56 | A | Line in sockets | |
| 10 | Play button | SK51 | B | Line out sockets | |
| 11 | Wind button | SK52 | C | Mains socket | |

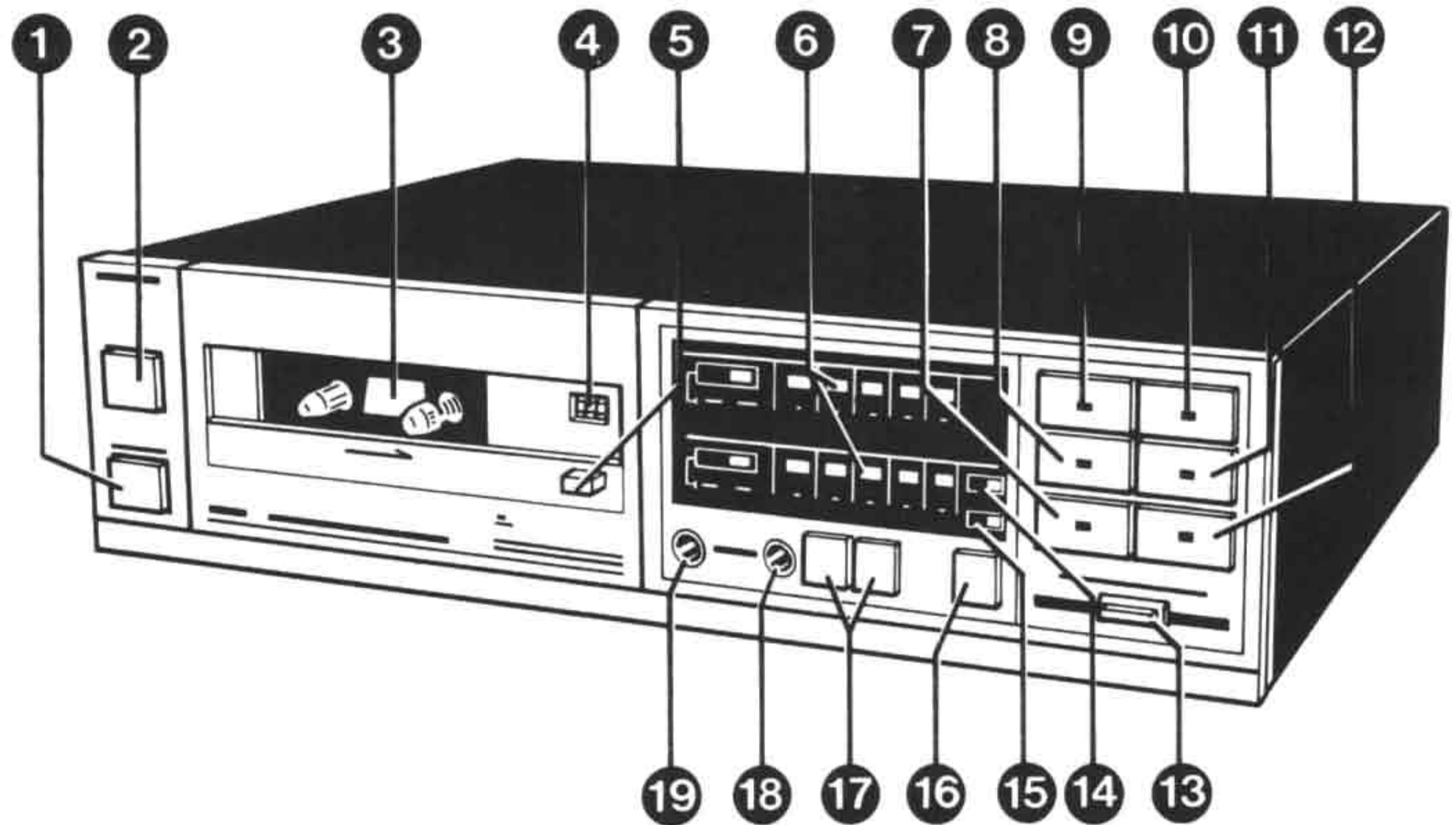

37 648 A12

Fig. 1

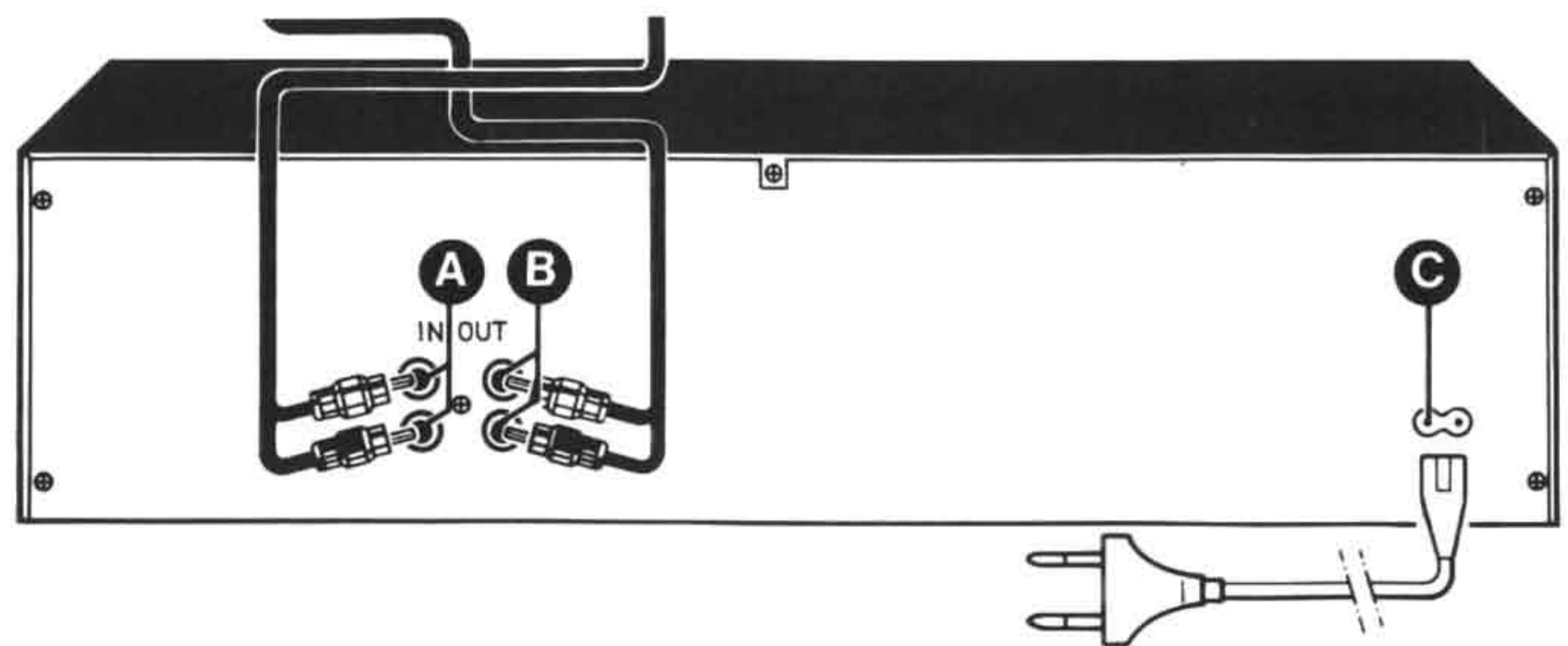

37 649 A12

Fig. 2

SK5
314
671
671
SK5
SK2
BU
BU
BU
BU

GB SERVICING HINTS

1. Disassembly of the tapedeck

- Remove top cover 556 (6 screws).
- Remove ornamental plate 406 of cassette lid (snap-in connection).
- Take belt 419 from counter pulley.
- Take coupling rod 554 from coupling piece 433 of SK1.
- Remove the 3 fixing screws of the tapedeck (2.9x30 mm).
- Now the tapedeck has been separated from the front.

2. Ornamental lid 406

Ornamental lid 406 is by means of a snap-in connection fixed to the cassette lid of the tapedeck.

- Remove the ornamental lid by pulling it forwards at the lower side of the tapedeck, with the cassette lid closed (Fig. 3).

3. Removal of ornamental plate 408

- Remove top cover 556 (6 screws).
- Push with a screwdriver the 4 lugs of ornamental plate 408 inwards out of front plate 403 (Fig. 3).
- Push the keys of SK2 through SK5 as deeply as possible inwards.
- Tilt ornamental plate 408 from above forwards and take the ornamental plate from the front.

4. Replacement of keys 409 and lens 421, 422, 423

- Remove ornamental plate 408 (see section 3).

5. Disassembly of main PCB U1000A (Fig. 3)

- Remove top cover 556 (6 screws)
- Remove 2 screws A, 3 screws B, 2 screws C and screw D.
- Hook spring E out of PCB.
- Slightly lift the front thus releasing the lower cabinet from the front and pull front together with PCB forwards out of the lower cabinet.

NL REPARATIEWENKEN

1. Uitkasten van het loopwerk

- Verwijder bovenkap 556 (6 schroeven).
- Sierplaat 406 van kassetteklep verwijderen (klikverbinding).
- Snaar 419 afnemen van tellerpoelie.
- Koppelstang 554 uit koppelstuk 433 van SK1 nemen.
- De 3 bevestigingsschroeven van het loopwerk (2.9x30 mm) verwijderen.
- Het loopwerk is nu los van het voorfront.

2. Sierklep 406

Sierklep 406 zit d.m.v. een klikverbinding op de kassetteklep van het loopwerk bevestigd.

- Verwijder de sierklep door deze aan de onderzijde van het loopwerk naar voren weg te trekken, terwijl de kassetteklep gesloten is (Fig. 3).

3. Verwijderen van sierplaat 408

- Verwijder bovenkap 556 (6 schroeven).
- Druk met een schroevendraaier de 4 lippen van de sierplaat 408 naar binnen uit frontplaat 403 (Fig. 3).
- Druk de toetsen van SK2 t/m SK5 zo diep mogelijk naar binnen.
- Kantel sierplaat 408, van boven uit naar voren en neem de sierplaat van het front weg.

4. Vervangen van de toetsen 409 en lens 421, 422, 423

- Verwijder sierplaat 408 (zie paragraaf 3).

5. Uitkasten van de hoofdprint U1000A (Fig. 3)

- Verwijder de bovenkap 556 (6 schroeven)
- Verwijder de schroeven A, de 3 schroeven B en de 2 schroeven C en schroef D.
- Veer E loshaken uit de print.
- Til het front iets omhoog zodat de onderkast van het front loskomt en trek daarna het front inclusief de print naar voren uit de onderkast.

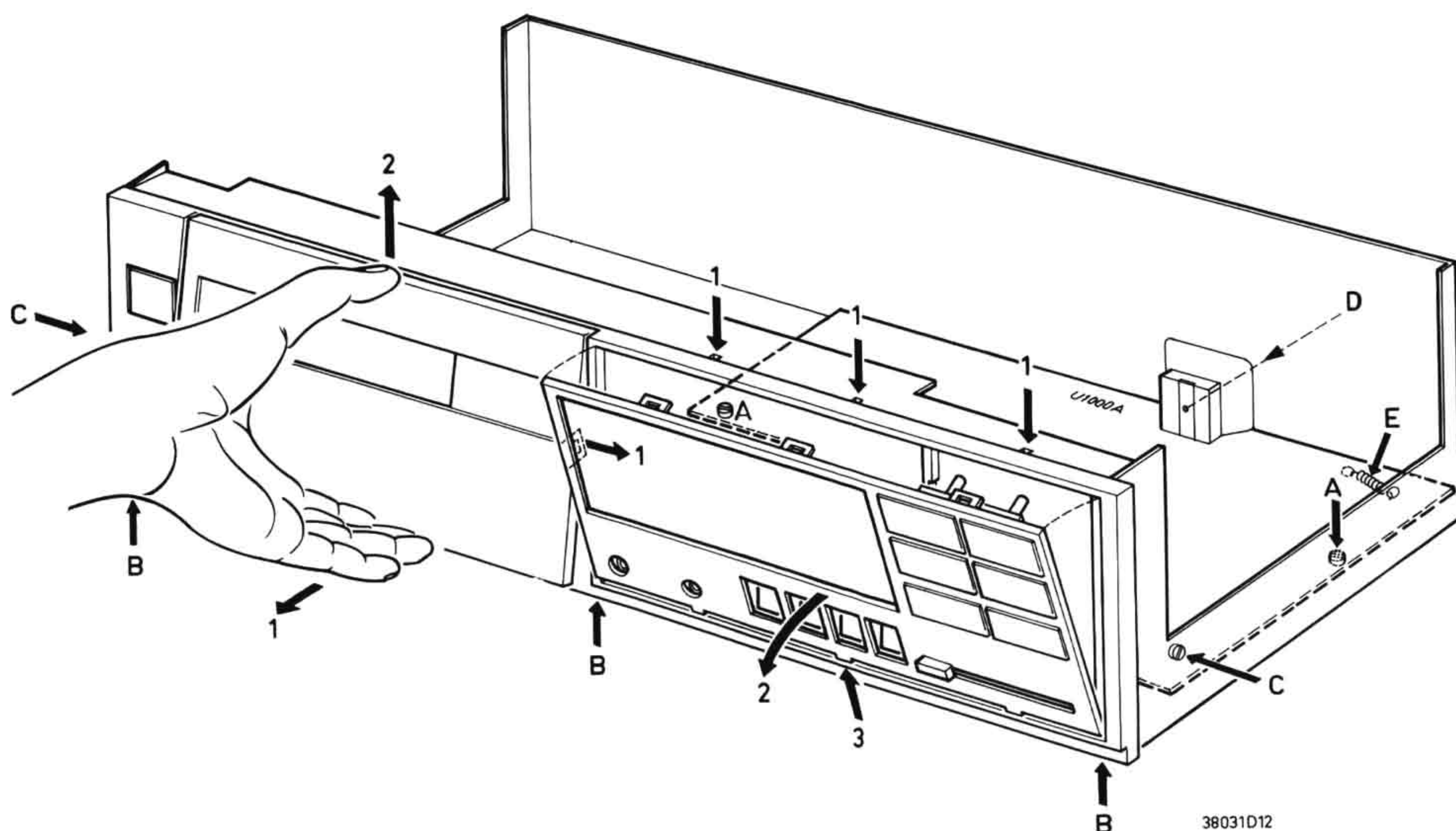

38031D12

Fig. 3

F CONSEILS REPARATION

1. Démontage du mécanisme

- Enlever le couvercle 556 (6 vis).
- Oter l'enjoliveur 406 du couvercle de cassette (fermeture à déclic).
- Décrocher la courroie 419 de la poulie du compte-tours.
- Détacher la tige 554 du couple 433 de SK1.
- Enlever les 3 de fixation du mécanisme (2.9x30 mm).
- Le mécanisme se détache ainsi de la façade.

2. Enjolivier 406

L'enjoliveur 406 est fixé au couvercle de cassette par une liaison à déclic.

- Enlever l'enjoliveur en le retirant en-dessous du mécanisme vers l'avant alors que le compartiment de cassette reste fermé (Fig. 3).

3. Retrait de l'enjoliveur 408

- Enlever le couvercle 556 (6 vis)
- A l'aide d'un tournevis, pousser les 4 languettes de l'enjoliveur 408 dedans, au travers de la façade 403 (Fig. 3).
- Presser aussi profondément que possible les touches de SK2 à SK5.
- Faire basculer l'enjoliveur 408 du haut vers l'avant et enlever l'enjoliveur de la façade.

4. Remplacement des touches 409 et de la lentille 421, 422, 423

- Enlever l'enjoliveur 408 (voir paragraphe 3).

5. Démontage de la platine principale U1000A (Fig. 3)

- Enlever le couvercle 556 (6 vis).
- Dévisser les 2 vis A, les 3 vis B, les 2 vis C et la vis D.
- Décrocher le ressort E de la platine
- Soulever légèrement la façade de sorte que le boîtier inférieur de la façade se détache et extraire ensuite la façade avec la platine du boîtier inférieur.

I CONSIGLI PER LA RIPARAZIONE

1. Smontaggio del meccanismo

- Togliere il coperchio 556 (6 viti).
- Levare la piastra decorativa 406 dal coperchio del vano cassette (chiusura a nottolino).
- Sganciare la cinghia 419 dalla puleggia del contagiri.
- Staccare l'asta 554 dalla coppia 433 di SK1.
- Togliere le 3 viti di fissaggio del meccanismo (2.9x30 mm).
- Il meccanismo si stacca così dalla fronte.

2. Piastra decorativa 406

La piastra 406 viene fissata al coperchio del vano cassette con un collegamento a scatto.

- Togliere la piastra mentre si tira da sotto al meccanismo verso la fronte, il vano cassette essendo chiuso (Fig. 3).

D REPARATURHINWEISE

1. Ausbau des Laufwerks aus dem Gehäuse

- Oberkappe 556 abnehmen (6 Schrauben).
- Zierplatte 406 von Cassettenfachklappe entfernen (Einschnappverbindung).
- Seil 419 von Zählerseilrolle abnehmen.
- Kupplungsstange 554 aus Kupplungsstück 433 von SK1 herausnehmen.
- Die 3 Befestigungsschrauben des Laufwerks (2.9x30 mm) herausdrehen.
- Das Laufwerk ist nun von der Front getrennt.

2. Zierklappe 406

Zierklappe 406 ist mittels einer Einschnappverbindung an der Cassettenfachklappe des Laufwerks befestigt.

- Zierklappe beseitigen, indem sie auf der Unterseite des Laufwerks nach vorne fortgezogen wird, während die Cassettenfachklappe geschlossen ist (Bild 3).

3. Abnahme der Zierplatte 408

- Oberkappe 556 abnehmen (6 Schrauben).
- Mit einem Schraubenzieher die 4 Zungen der Zierplatte 408 einwärts aus Frontplatte 403 (Bild 3) hinausdrücken
- Die Tasten von SK2 bis SK5 möglichst tief einwärtsdrücken.
- Zierplatte 408 von oben aus nach vorne kippen und die Zierplatte von der Front fortnehmen.

4. Auswechseln der Tasten 409 und der Linse 421, 422, 423

- Zierplatte 408 (siehe Abschnitt 3) abnehmen.

5. Ausbau der Hauptplatine U1000A (Bild 3)

- Oberkappe 556 (6 Schrauben) abnehmen.
- 2 Schrauben A, 3 Schrauben B, 2 Schrauben C und Schraube D lösen.
- Feder E aus der Platine aushängen
- Vorderfront ein wenig heben, so dass sich das Untergehäuse von der Vorderfront löst und dann die Vorderfront samt Platine aus dem Untergehäuse vorwärtsziehen.

3. Togliere la piastra decorativa 408

- Togliere il coperchio 556 (6 viti)
- Per mezzo di un cacciavite spingere le 4 linguette della piastra 408 in alto attraverso il fronte 403 (Fig. 3).
- Spingere il più profondamente possibile i tasti da SK2 a SK5.
- Ribaltare la piastra decorativa 408 dall'alto verso l'avanti e togliere la piastra dal fronte.

4. Sostituzione dei tasti 409 e la lente 421, 422, 423

- Togliere la piastra 408 (vedi paragrafo 3).

5. Smontaggio della piastra principale U1000A (Fig. 3)

- Togliere il coperchio 556 (6 viti).
- Svitare le 2 viti A, le 3 viti B, le 2 viti C e la vite D.
- Sganciare la molla E dalla piastra.
- Sollevare un poco il fronte in modo che la cassa inferiore del fronte si stacca, estiarre quindi il front' con la piastra dalla cassa inferiore.

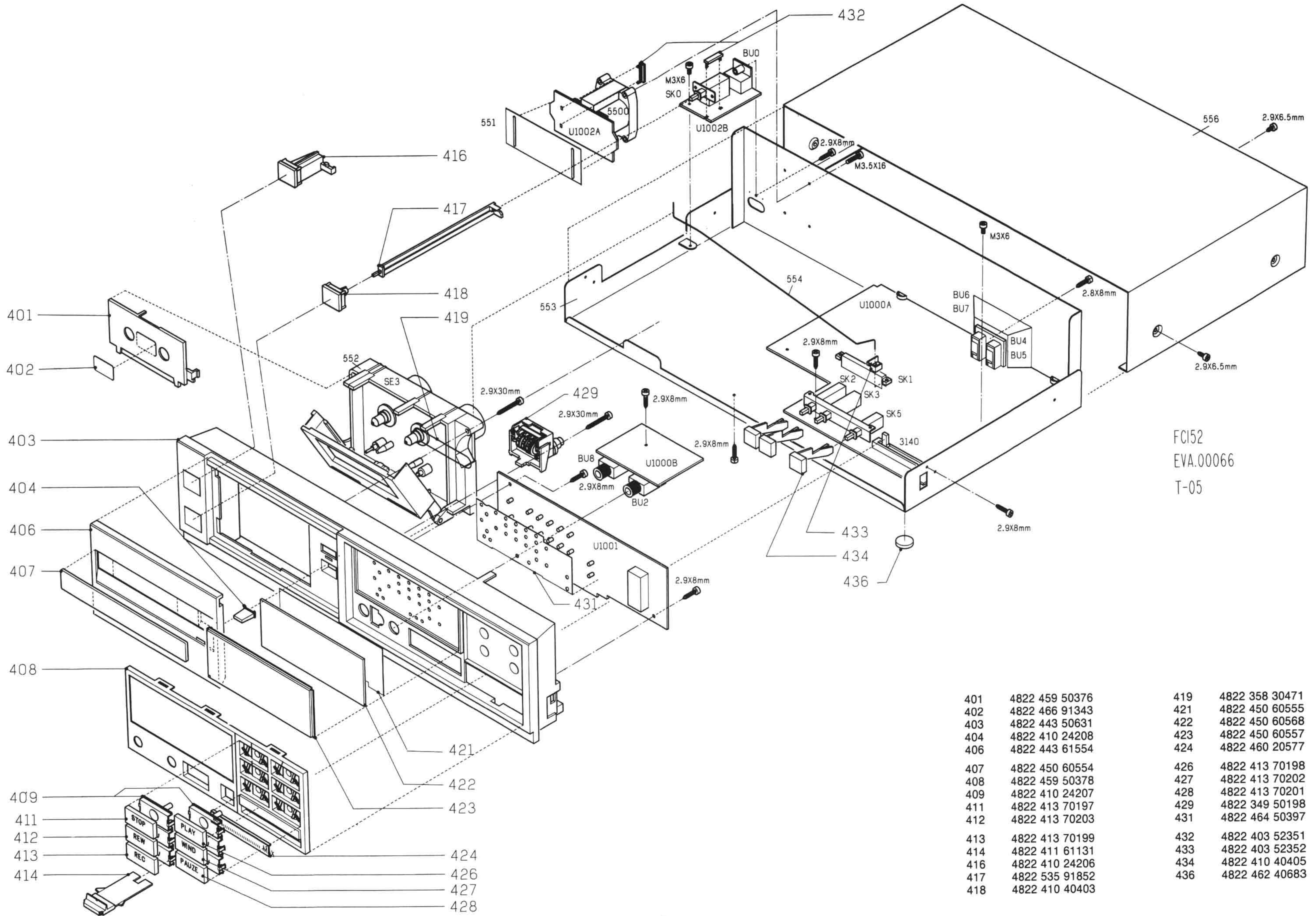

FCI52
EVA.00066
T-05

401	4822 459 50376	419	4822 358 30471
402	4822 466 91343	421	4822 450 60555
403	4822 443 50631	422	4822 450 60568
404	4822 410 24208	423	4822 450 60557
406	4822 443 61554	424	4822 460 20577
407	4822 450 60554	426	4822 413 70198
408	4822 459 50378	427	4822 413 70202
409	4822 410 24207	428	4822 413 70201
411	4822 413 70197	429	4822 349 50198
412	4822 413 70203	431	4822 464 50397
413	4822 413 70199	432	4822 403 52351
414	4822 411 61131	433	4822 403 52352
416	4822 410 24206	434	4822 410 40405
417	4822 535 91852	436	4822 462 40683
418	4822 410 40403		

Fig.4

ELECTRICAL MEASUREMENTS AND ADJUSTMENTS

General conditions

The following general conditions apply to the electrical measurements and adjustments, unless explicitly stated otherwise.

- Mains voltage 220 V \pm 5%, 50 Hz
- Ambient temperature 20 to 25°C
- Dolby switch SK5 off
- Volume control recording level 3140 max.
- The voltages have been measured relative to earth.

- The measurements and adjustments are related to the lefthand channel.

The corresponding test points and adjusting elements for the right-hand channel are given in brackets.

Required test equipment and test cassettes

- LF generator
- AC millivoltmeter (mV-meter)
- Wow-and-flutter-meter
- Universal test cassette SBC419Cr – 4822 397 30069
- Multimeter
- Frequency counter

Adjustment	Cassette	Recorder in position	Apply signal to	Measure on	Read on	Adjust with	Value
Playback speed motor M1	SBC419 3150 Hz	PLAY	-	BU6 (BU7)	Wow-and-flutter meter (Filter on)	Variable resistor at the back of motor M1	*b
Playback sensitivity	SBC419 315 Hz-0 dB	PLAY	-	BU6 (BU7)	mV-meter	3108 (3109)	650 mV
Playback frequency response	SBC419 40 Hz;250 Hz; 6.3 kHz; 12.5 kHz	PLAY	-	BU6 (BU7)	mV-meter	-	See graph Fig. 6 frequency response
Target value BIAS	Chromium cassette	REC	-	MP1 (MP101)	mV-meter	3266 (3267)	16.5 mV
Recording sensitivity	SBC419 side 2 *c	REC + PLAY	315 Hz,to BU4 (BU5)	BU6 (BU7)	mV-meter	LF-generator	290 mV
				Disable the bias by removing (or interrupting) jumper 9028			
				MP1 (MP101)	mV-meter	3264 (3265)	1.6 mV
				Connect jumper 9028 make a recording and play it back			
BIAS	SBC419 side 2 *c	REC + PLAY	-	MP1 (MP101)	mV-meter	3266 (3267)	16.5 mV
			315 Hz, to BU4 (BU5)	BU6 (BU7)	mV-meter	LF-generator	29 mV
			40 Hz-6.3 kHz 10 kHz-12 kHz 14 kHz-15 kHz 16 kHz,to BU4 (BU5)	Record a number of frequencies with the same input voltage and play them back			
			PLAY	-	BU6 (BU7)	mV-meter	-
f-osc.	Arbitrary cassette	REC	-	MP2	Frequency counter	5103	85 kHz
19/85 kHz suppression	Arbitrary cassette	REC	315 Hz, to BU4 (BU5)	BU6 (BU7)	mV-meter	LF-generator	775 mV
			19 kHz, to BU4 (BU5) (same input voltage)	BU6 (BU7)	mV-meter	5106 (5107)	\leq 25 mV
			f-osc. to BU4 (BU5) (same input voltage)	BU6 (BU7)	mV-meter	-	Min output \leq 4.35 mV

(GB) Notes:

- *a. Prior to any measurement or adjustment with the tape running, heads and tape guides should be degaussed and cleaned.
- *b. The max. permissible speed deviation $\pm 1.5\%$. Moreover, the wow-and-flutter can be read. This value should not exceed 0.13% .
- *c. If the accuracy requirements are less stringent a high quality chromium cassette may be used as an alternative.
- *d. The output voltage on BU6 (BU7) should read $290\text{ mV} \pm 0.25\text{ dB}$.
If this is not the case reduce the LF-signal (bias disabled) by as many dB's as the reading was too low or too high by means of 3264 (3265).
- *e. When one channel is adjusted this may slightly affect the adjustment of the other channel.
If the adjustment is correct the frequency response curve will be similar to curve b in Fig. 8, distortion $\leq 3\%$.

(F) Remarques:

- *a. Le chaque mesure ou réglage à la chaîne, les têtes et guide-bande doivent être démagnétisées et nettoyées.
- *b. Ecart maximum admissible $\pm 1.5\%$.
On pourra aussi lire le niveau de pleurage que ne doit pas dépasser $0,13\%$.
- *c. Si les exigences point vue précision ne sont pas tellement élevées, une cassette au chrome de bonne qualité pourra aussi convenir.
- *d. La tension de sortie doit afficher $290\text{ mV} \pm 0.25\text{ dB}$.
Si ce n'était pas le cas, régler avec 3264 (3265) le signal AF (prémagnétisation exclue) d'autant de dB en-dessous ou au-dessus du résultat de l'affichage qui serait trop haut ou trop bas.
- *e. Lors du réglage d'un des canaux on pourrait constater qu'il y a incidence sur l'autre.
Si le réglage est comme il faut, la courbe de fréquence aura la forme de celle de la Fig. 8. courbe b, distorsion $\leq 3\%$.

(I) Note:

- *a. Prima di effettuare della misure o regolazioni con la cassetta inserita, le testine e le guide nastro devono essere smagnetizzate e pulite.
- *b. Massima deviazione tollerata $\pm 1.5\%$.
Può essere letto anche il wow. Questo può essere come massimo $0,13\%$.
- *c. Si il controllo non deve essere molto accurato, si può utilizzare una cassetta al cromo di alta qualità.

(NL) Opmerkingen:

- *a. Voor alle metingen en instellingen met lopende band dienen de koppen en bandgeleiders gedemagnetiseerd en gereinigd te worden.
- *b. Max. toelaatbare snelheidsafwijking $\pm 1.5\%$.
Tevens kan bij deze meting de jengelwaarde worden afgelezen. Deze mag max. 0.13% bedragen.
- *c. Bij minder hoge nauwkeurigheid kan ook een chromiumcassette van goede kwaliteit gebruikt worden.
- *d. Indien de uitgangsspanning op BU6 (BU7) geen $290\text{ mV} \pm 0.25\text{ dB}$ is regel dan met 3264 (3265) het LF signaal (voormagnetisatie uitgeschakeld) zoveel dB lager of hoger als de meteruitslag te hoog of te laag is.
- *e. Bij het instellen van het ene kanaal kan het andere iets worden beïnvloed.
Bij een goede instelling zal de frequentie karakteristiek als in Fig. 8 curve b. verlopen, vervorming $\leq 3\%$.

(D) Anmerkungen:

- *a. Vor jeder Messung oder Einstellung mit laufendem Band empfiehlt es sich, die Köpfe und Bandführungen zu entmagnetisieren und zu reinigen.
- *b. Maximal zulässige Geschwindigkeitsabweichung $\pm 1.5\%$.
Auch kann der Jaulwert abgelesen werden, der höchstens 0.13% betragen darf.
- *c. Bei weniger hoher Genauigkeit lässt sich auch eine Chromium-Cassette guter Qualität verwenden.
- *d. Die Ausgangsspannung an BU6 (BU7) muss $290\text{ mV} \pm 0.25\text{ dB}$ anzeigen, Ist dass nicht der Fall, dann mit 3264 (3265) das NF-Signal (Vormagnetisierung ausgeschlossen) um soviel dB niedriger oder höher einstellen als die Messeranzeige zu hoch oder zu niedrig war.
- *e. Beim Einstellen des einen Kanals kann der andere etwas beeinflusst werden.
Bei einer entsprechenden Einstellung verläuft der Frequenzgang wie in Abb. 8 Kurve b, Verzerrung $\leq 3\%$.

- *d. Gli la tensione d'uscita devono essere su $290\text{ mV} \pm 0.25\text{ dB}$
Se ciò non è aumentare o ridurre il segnale AF (bias disinserito), in funzione della indicazione, in dB, troppo bassa o troppo alta, per mezzo di 3264 (3265).
- *e. Quando viene regolato un canale, questo può influire sulla regolazione dell'altro.
Se la regolazione è corretta la curva della risposta in frequenza sarà simile alla curva b della Fig. 8. Distorsione aumenterà $\leq 3\%$.

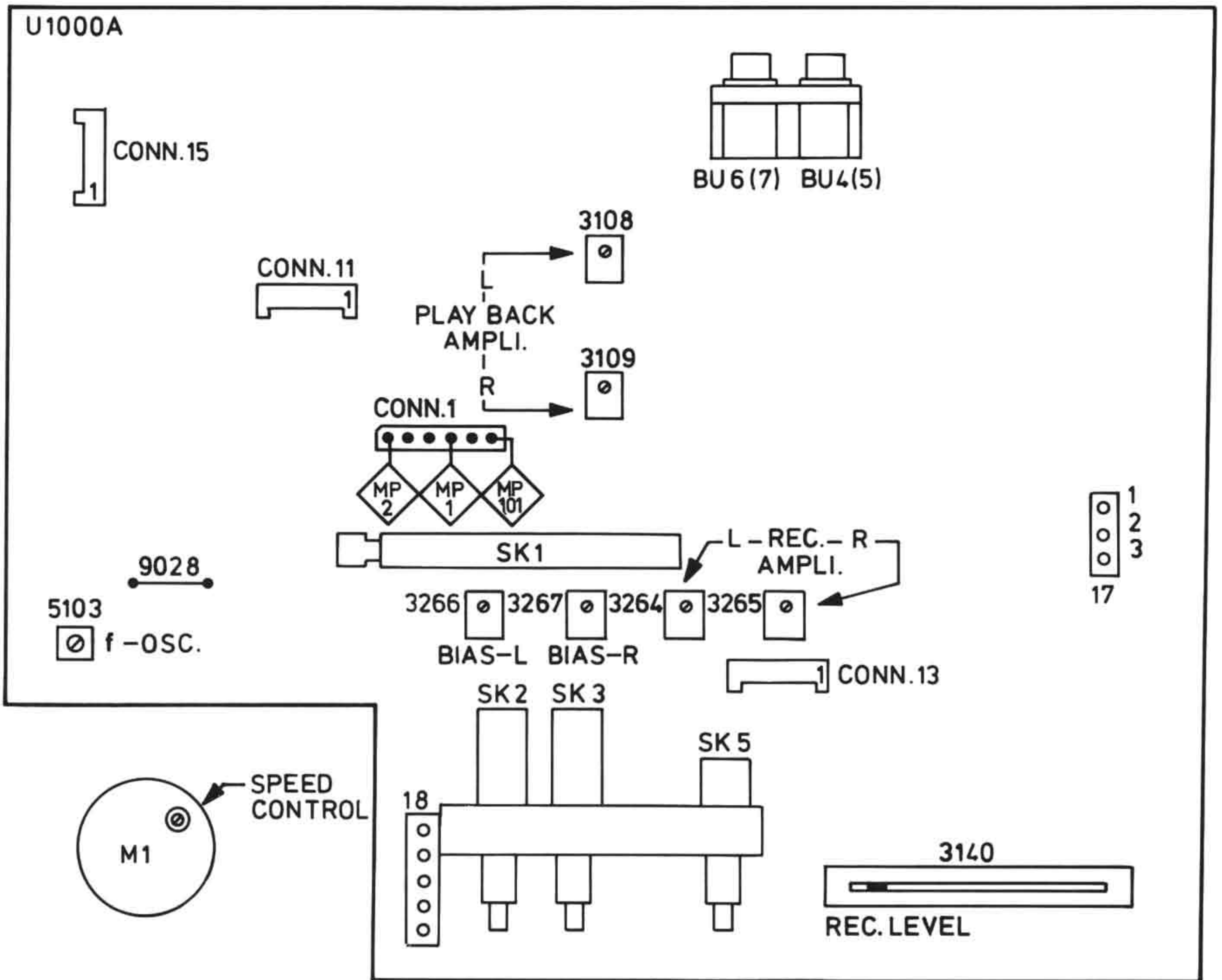

Fig.5

37 973 B12

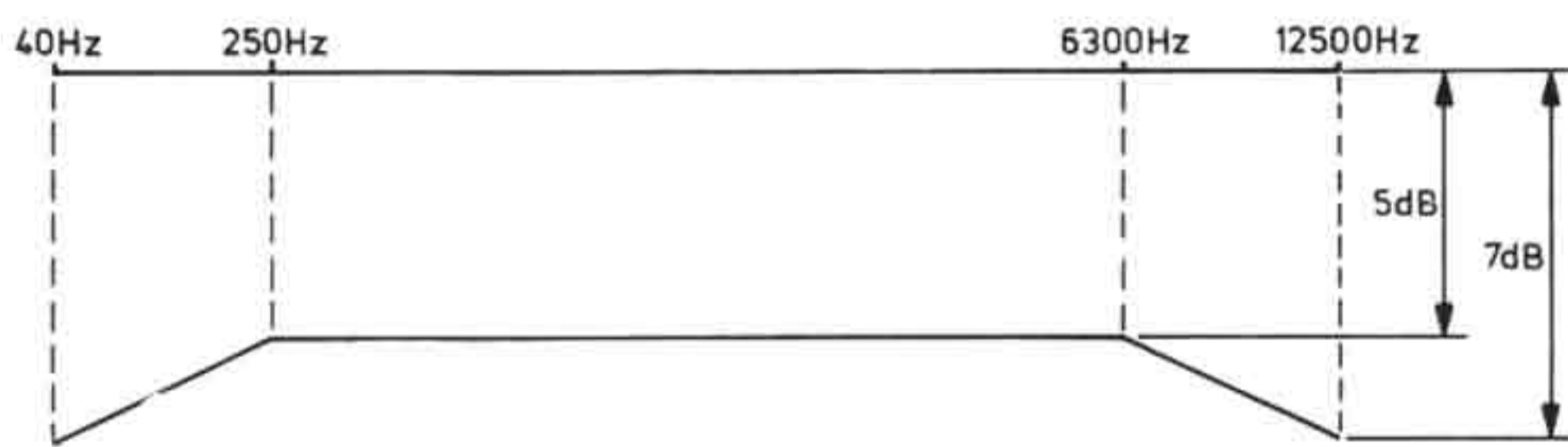
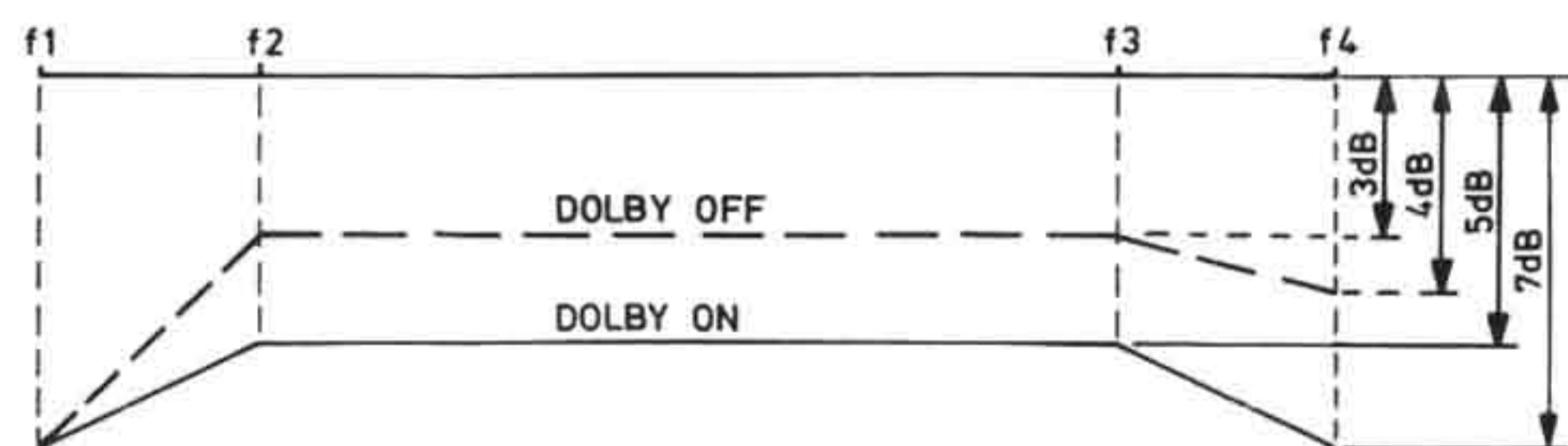

Fig.6

13282A2



29 612 A12

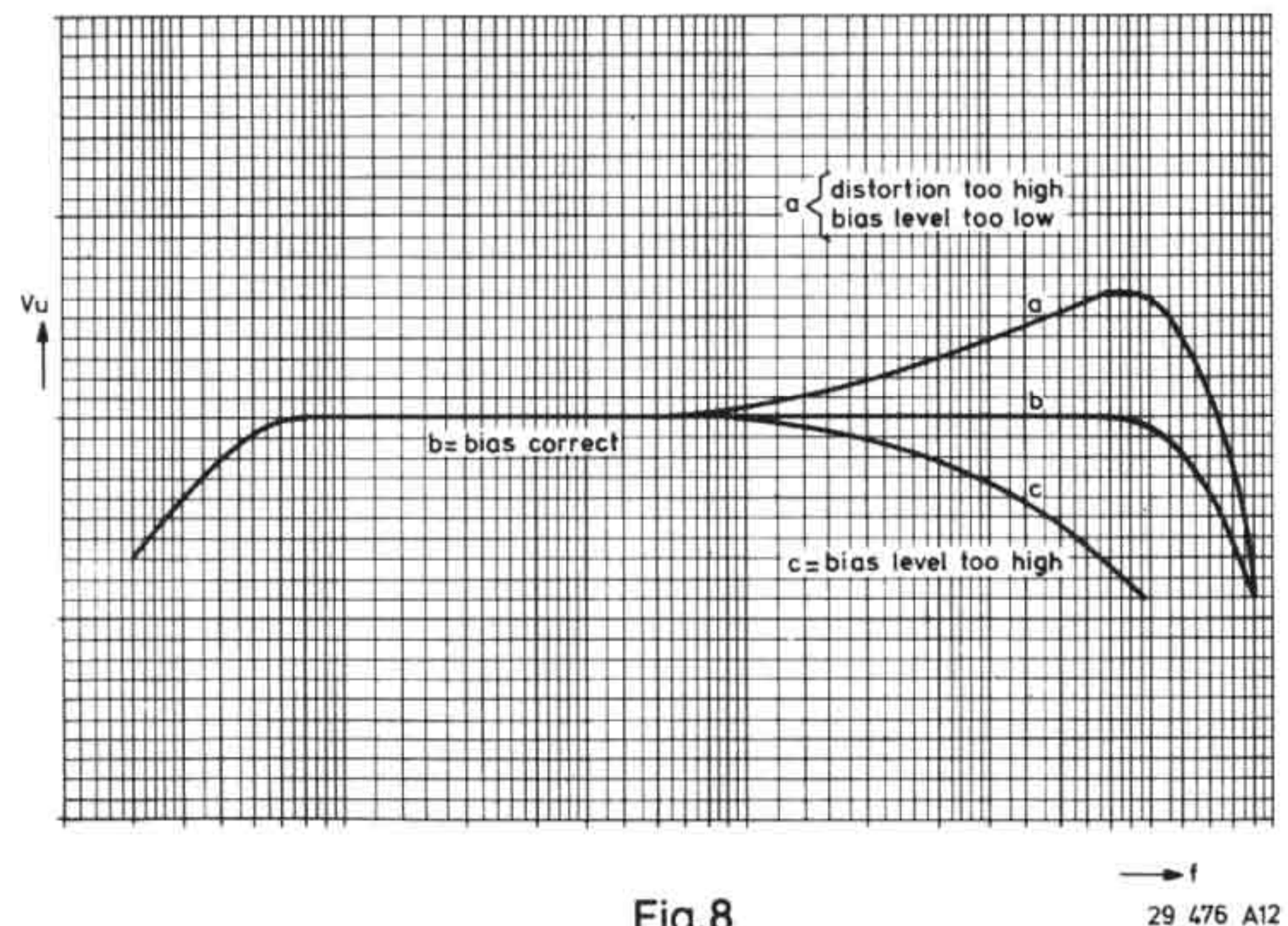

Fig.8

29 476 A12

	f1	f2	f3	f4
Metal	30 Hz	125 Hz	8 KHz	14 KHz
Cr	30 Hz	125 Hz	8 KHz	13 KHz
Normal	30 Hz	125 Hz	8 KHz	12.5 KHz

Fig.7

WIRING DIAGRAM

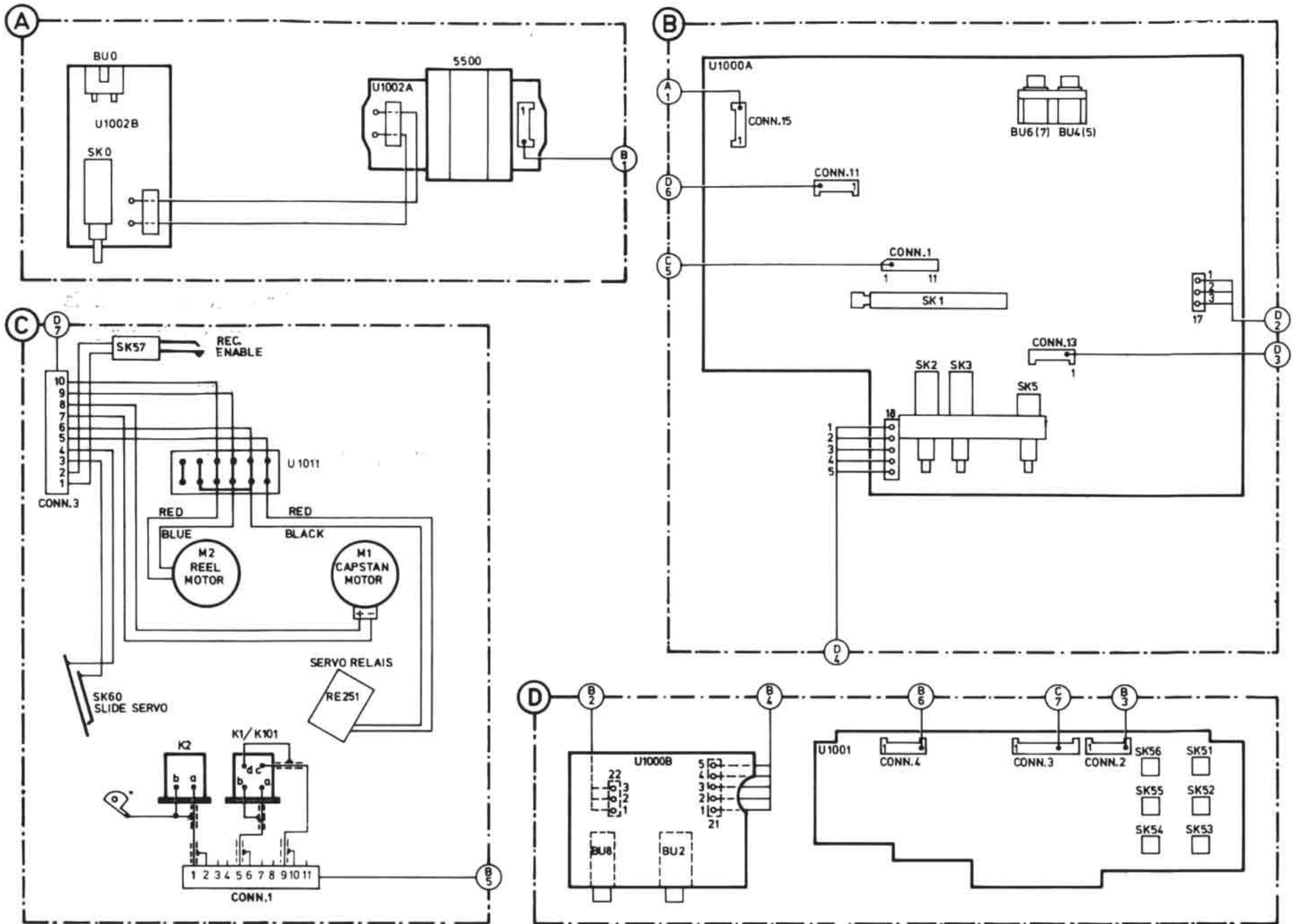

37877C07

Fig.9

	Carbon film 0.2 W 70°C 5%		Ceramic plate Tuning ≤ 120 pF NP.0 2% Others -20/+80%	*a = 2,5 V b = 4 V c = 6,3 V d = 10 V e = 16 V f = 25 V g = 40 V h = 63 V j = 100 V l = 125 V m = 150 V n = 160 V q = 200 V r = 250 V s = 300 V t = 350 V u = 400 V v = 500 V w = 630 V x = 1000 V A = 1,6 V B = 6 V C = 12 V D = 15 V E = 20 V F = 35 V G = 50 V H = 75 V I = 80 V
	Carbon film 0.33 W 70°C 5%		Polyester flat foil 10%	
	Metal film 0.33 W 70°C 5%		Metalized polyester flat film 10%	
	Carbon film 0.5 W 70°C 5%		Polyester flat foil small size (Mylar) 10%	
	Carbon film 0.67 W 70°C 5%		Polysterene film/foil 1%	
	Carbon film 1.15 W 70°C 5%		Tubular ceramic	
	Chip component		Miniature single	
			Subminiature tantalum $\pm 20\%$	

27 037A/C

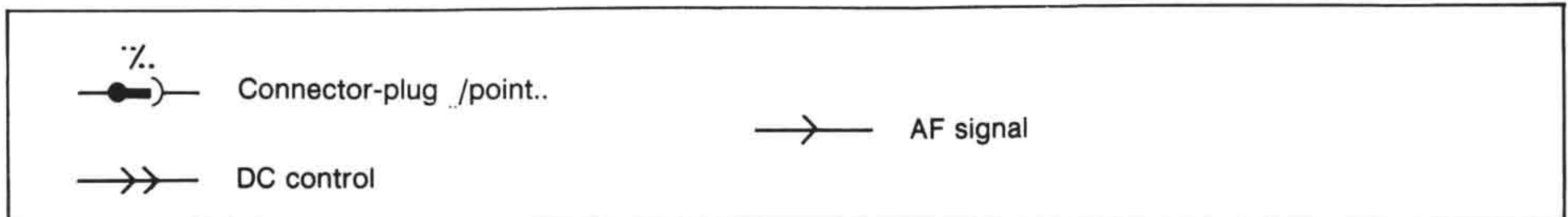



Fig.10

2100	E07	3140	I03	7126	B06
2101	E07	3142	H04	7139	C10
2104	D07	3143	H04	7140	G04
2105	D07	3190	C04	7141	G03
2106	E07	3191	D04	7142	E10
2107	E07	3192	C05	7143	E10
2108	D06	3193	D05	7150	B09
2109	E06	3194	C05	9028	E10
2121	H10	3195	E05	BU-2	I10
2123	H10	3196	C05	BU-4	B04
2130	D05	3197	E05	BU-5	B05
2131	F04	3198	F03	BU-6	B05
2132	C05	3200	C03	BU-7	B05
2133	E05	3201	C03	BU-8	I09
2136	C04	3202	B05	SK-1	E06
2137	D04	3203	C03	SK-2	I07
2138	C04	3204	B03	SK-3	I07
2139	D04	3205	B02	SK-5	I05
2140	C04	3210	C03		
2141	D04	3211	C03		
2142	C05	3212	C02		
2143	D05	3213	C02		
2144	C04	3214	C03		
2145	D04	3215	C03		
2146	C05	3216	C02		
2147	D05	3217	C02		
2148	C05	3218	D02		
2149	E05	3219	D02		
2150	D05	3220	D02		
2151	E05	3221	D02		
2152	F04	3230	B06		
2154	D03	3231	C06		
2155	E03	3232	B07		
2156	C03	3233	C07		
2157	E03	3234	B06		
2180	C02	3235	C06		
2181	C02	3236	B07		
2182	D03	3237	C07		
2183	D02	3238	B06		
2190	B06	3239	C06		
2191	C06	3240	B07		
2192	B07	3241	C07		
2193	C07	3242	D08		
2194	B06	3243	D08		
2195	C06	3244	D09		
2196	B07	3245	D08		
2197	C07	3248	B07		
2198	B07	3249	B07		
2199	C07	3250	C07		
2200	C07	3251	C07		
2201	D07	3252	H07		
2202	B06	3253	H07		
2203	C06	3256	H06		
2206	G07	3257	H07		
2207	G07	3262	F07		
2208	G07	3263	F06		
2209	G07	3264	F06		
2210	G06	3265	F05		
2211	G07	3266	F07		
2212	G06	3267	F06		
2213	G05	3279	C10		
2214	F08	3280	G03		
2215	F08	3281	F04		
2220	F10	3282	G03		
2221	E10	3283	G04		
2222	E10	3284	C04		
2223	E10	3285	C08		
2224	F10	3286	H07		
2225	F04	3287	H07		
2230	D06	3289	E10		
2231	G10	3290	E10		
2232	C09	3292	E10		
2233	B09	3300	D06		
2234	B09	3301	H04		
2235	C10	3302	B09		
2236	B10	5100	G06		
3100	E07	5101	G05		
3101	E07	5103	F10		
3102	D07	5106	C03		
3103	D07	5107	E03		
3104	B08	6112	F03		
3105	E06	6113	B09		
3106	E08	6114	C09		
3107	E06	6118	G05		
3108	D06	6150	B10		
3109	E06	6151	B10		
3110	D08	6152	B10		
3111	D06	6153	B10		
3112	D08	6154	B10		
3113	E06	6155	B10		
3114	C05	7100	E07		
3115	E05	7102	D08		
3121	G10	7103	B06		
3125	G10	7105	G10		
3127	G10	7120	B02		
3129	H10	7121	B02		
3130	B03	7122	C02		
3131	B02	7123	C02		
3132	B04	7124	C04		
3133	B04	7125	E04		

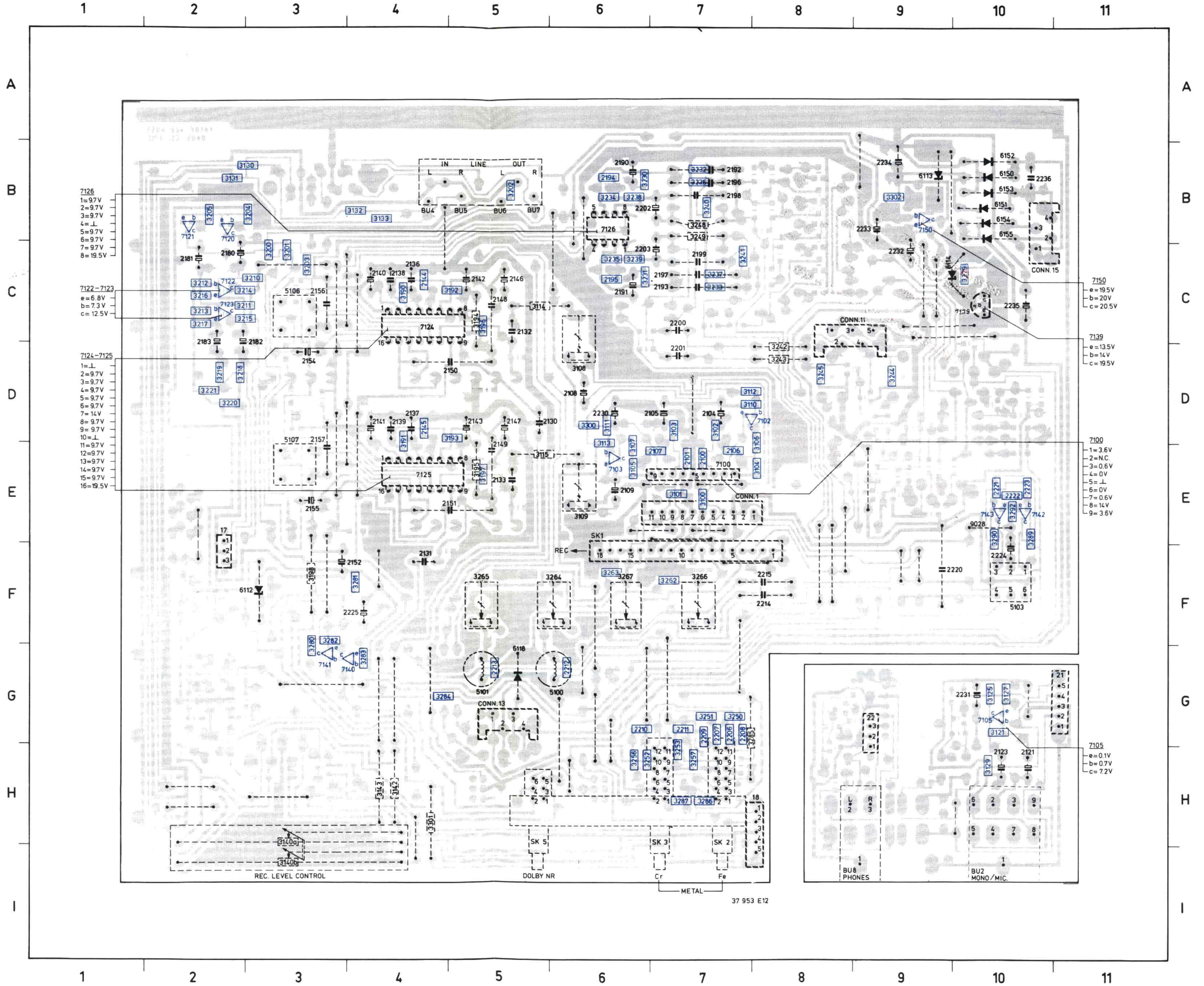

Fig. 11

CONTROL PCB U1001 (VERSION WITH SE-2 MC6804P2P/SC94005)

2702	G14	2717	E13	2760	E9	3700	G13	3705	F15	3710	H10	3715	F12	3722	R2	3732	B15	3737	B12	3744	F9	3789	E2	3794	H12	6705	F15	6719	G13	6786	C8	6791	F7	6796	C4	7703	F15	7725	H13	M2	D18	SK54	D9
2708	B3	2732	C15	2761	C9	3701	F13	3706	G16	3711	R11	3717	E13	3723	R3	3733	B14	3738	C12	3766	D9	3790	C4	3795	H12	6713	F16	6721	B3	6787	F8	6792	C6	6797	F4	7705	F15	7730	R14	RE215	F18	SK55	C9
2709	B10	2734	B14	2790	C3	3702	F14	3707	G16	3712	F15	3718	H13	3729	H2	3734	C14	3740	H11	3780	G8	3781	F4	3796	H11	6716	F13	6730	R15	6788	C7	6793	F6	7700	B12	7713	F16	7730	R12	SK51	D9	SK56	B9
2711	B11	2737	B13	2791	F3	3703	G14	3708	G9	3713	E16	3719	G13	3730	R15	3735	B13	3741	B9	3781	G8	3792	B6	3796	R4	6717	F13	6734	B13	6789	C7	6794	C5	7701	C14	7716	F12	7790	C2	SK52	C9	SK57	E9
2714	C13	2739	B10	2795	C2	3704	G14	3709	R11	3714	C13	3721	B2	3731	C15	3736	C13	3741	G12	3782	G2	3793	G6	6703	F15	6718	H13	6779	E2	6790	C7	6795	F5	7702	F14	7721	R3	M1	D18	SK53	C9	SK60	B18



Fig. 12

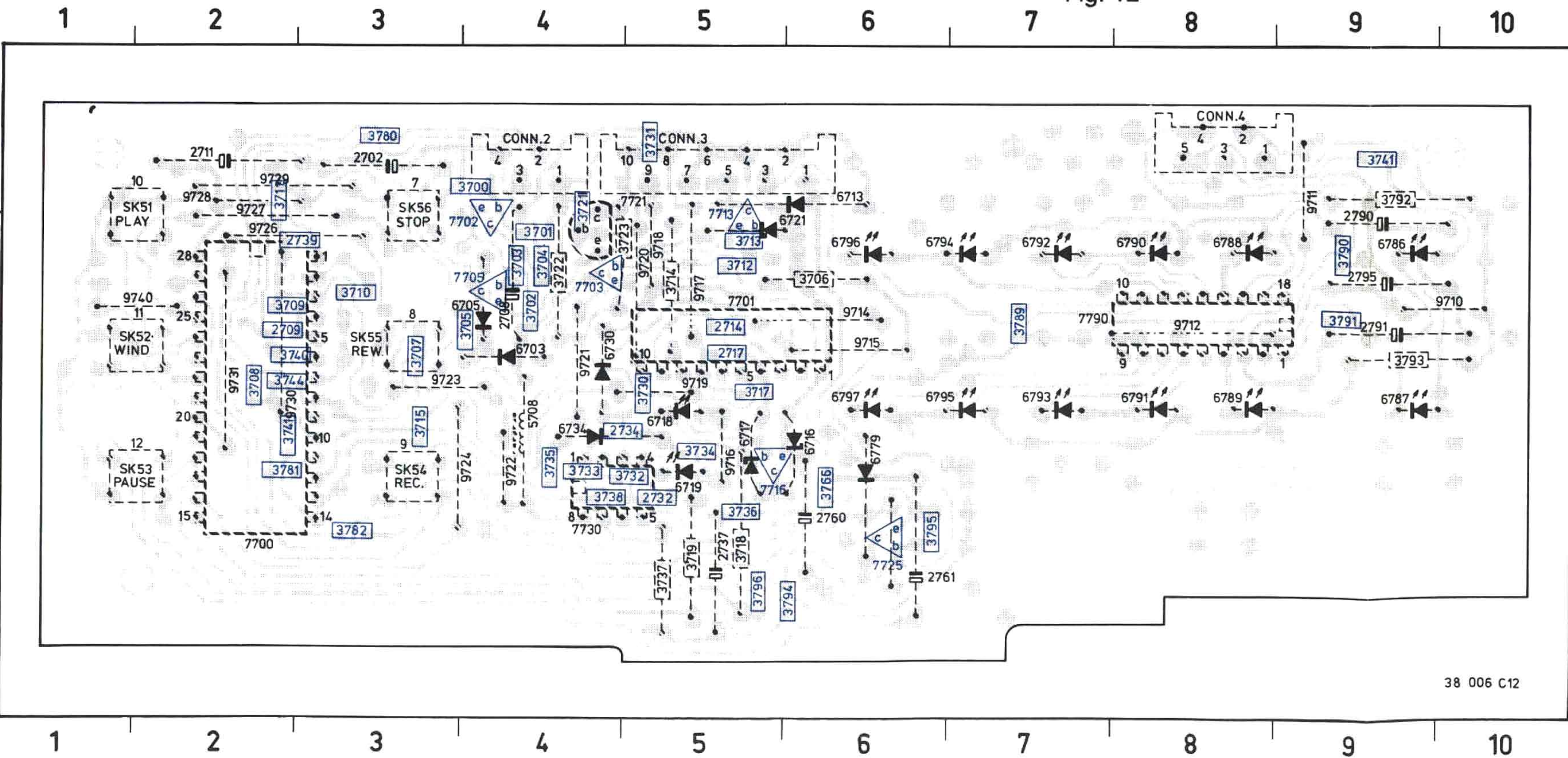

Fig. 13

2702	A03	3722	B04	6734	C04
2708	B04	3723	B05	6779	C06
2709	B02	3730	C05	6786	B09
2711	A02	3731	A05	6787	C09
2714	B05	3732	C05	6788	B08
2717	B05	3733	C04	6789	C08
2732	C05	3734	C05	6790	B08
2734	C05	3735	C04	6791	C08
2737	D05	3736	C05	6792	B07
2739	B02	3737	D05	6793	C07
2760	C06	3738	C04	6794	B07
2761	D06	3740	B02	6795	C07
2790	B09	3741	C02	6796	B06
2791	B09	3744	C02	6797	C06
2795	B09	3766	C06	7700	C02
3700	A04	3780	A03	7701	B05
3701	B04	3781	C02	7702	A04
3702	B04	3782	C03	7703	B04
3703	B04	3786	B07	7705	B04
3704	B04	3790	B09	7713	A06
3705	B04	3791	B09	7716	C05
3706	B06	3792	A09	7721	A05
3707	B03	3793	B09	7725	D06
3708	C02	3794	D06	7730	C04
3709	B02	3795	C06	7790	B08
3710	B03	3796	D05	9740	B02
3711	A02	5708	C04	SK51	B02
3712	B05	6703	B04	SK52	B02
3713	B05	6705	B04	SK53	C02
3714	B05	6716	C06	SK54	C03
3715	C03	6717	C05	SK55	B03
3717	C05	6718	C05	SK56	A03
3718	C05	6719	C05		
3719	D05	6721	B05		
3721	A04	6730	B04		

CONTROL PCB U1001 (VERSION WITH SE-3 MC68042P/SC94006)

2702	D14	2714	C13	2737	B13	2795	C 2	3703	G14	3707	G16	3712	F15	3717	E13	3722	A 2	3730	A15	3734	C14	3738	C12	3744	F 9	3789	E 2	3793	G 6	6713	F16	6719	G13	6779	E 2	6789	F 7	6793	F 6	6797	F 4	7703	F15	7721	A 3	M1	I18	SK52	C 9	SK56	B 9		
2708	B 3	2717	E13	2739	B10	2700	G13	3704	G14	3708	G 9	3713	E16	3718	H13	3723	A 2	3731	C15	3735	B13	3740	H11	3780	G 8	3781	G 8	3781	F 4	6703	F15	6717	F12	6721	B 3	6786	E 9	6790	C 7	6794	C 5	7700	B11	7705	F15	7730	A14	M2	D18	SK53	C 9	SK57	E 9
2709	B10	2732	C15	2790	C 3	3701	F13	3705	F15	3709	A11	3714	C13	3719	G13	3728	H10	3732	B15	3736	C13	3741	B 9	3781	G 8	3781	F 4	6703	F15	6717	F12	6730	A15	6787	E 9	6791	F 7	6795	C 5	7701	C14	7713	F15	7730	A12	RE251	F18	SK54	D 9	SK55	C 9	SK60	D18
2711	B11	2734	B14	2791	F 3	3702	F14	3706	G16	3711	A11	3715	F12	3721	B 2	3729	H 2	3733	B14	3737	B12	3741	D12	3782	G 2	3782	G 2	6705	F14	6718	H13	6734	B13	6788	C 7	6792	C 6	6796	C 4	7702	F14	7716	F12	7790	C 2	SK51	D 9	SK55	C 9				



Fig. 14

2702	A03	3719	D05	6717	C05	9725	C03
2708	B04	3721	A04	6718	C05	9732	B02
2709	B02	3722	B04	6719	C05	SK51	B02
2711	A02	3723	B05	6721	B05	SK52	B02
2714	B05	3728	B02	6730	B04	SK53	C02
2717	B05	3729	B02	6734	C04	SK54	C03
2732	C05	3730	C05	6779	C06	SK55	B03
2734	C05	3731	A05	6786	B09	SK56	A03
2737	D05	3732	C05	6787	C09		
2739	B02	3733	C04	6788	B08		
2790	B09	3734	C05	6789	C08		
2791	B09	3735	C04	6790	B08		
2795	B09	3736	C05	6791	C08		
3700	A04	3737	D05	6792	B07		
3701	B04	3738	C04	6793	C07		
3702	B04	3740	B02	6794	B07		
3703	B04	3741	C02	6795	C07		
3704	B04	3744	C02	6796	B06		
3705	B04	3780	A03	6797	C06		
3706	B06	3781	C02	7700	C02		
3707	B03	3782	C03	7701	B05		
3708	C02	3786	B07	7702	A04		
3709	B02	3790	B09	7703	B04		
3711	A02	3791	B09	7705	B04		
3712	B05	3792	A09	7713	A05		
3713	B05	3793	B09	7716	C05		
3714	B05	5708	C04	7721	A05		
3715	C03	6703	B04	7730	C04		
3717	C05	6705	B04	7790	B08		
3718	C05	6716	C06	9713	D06		

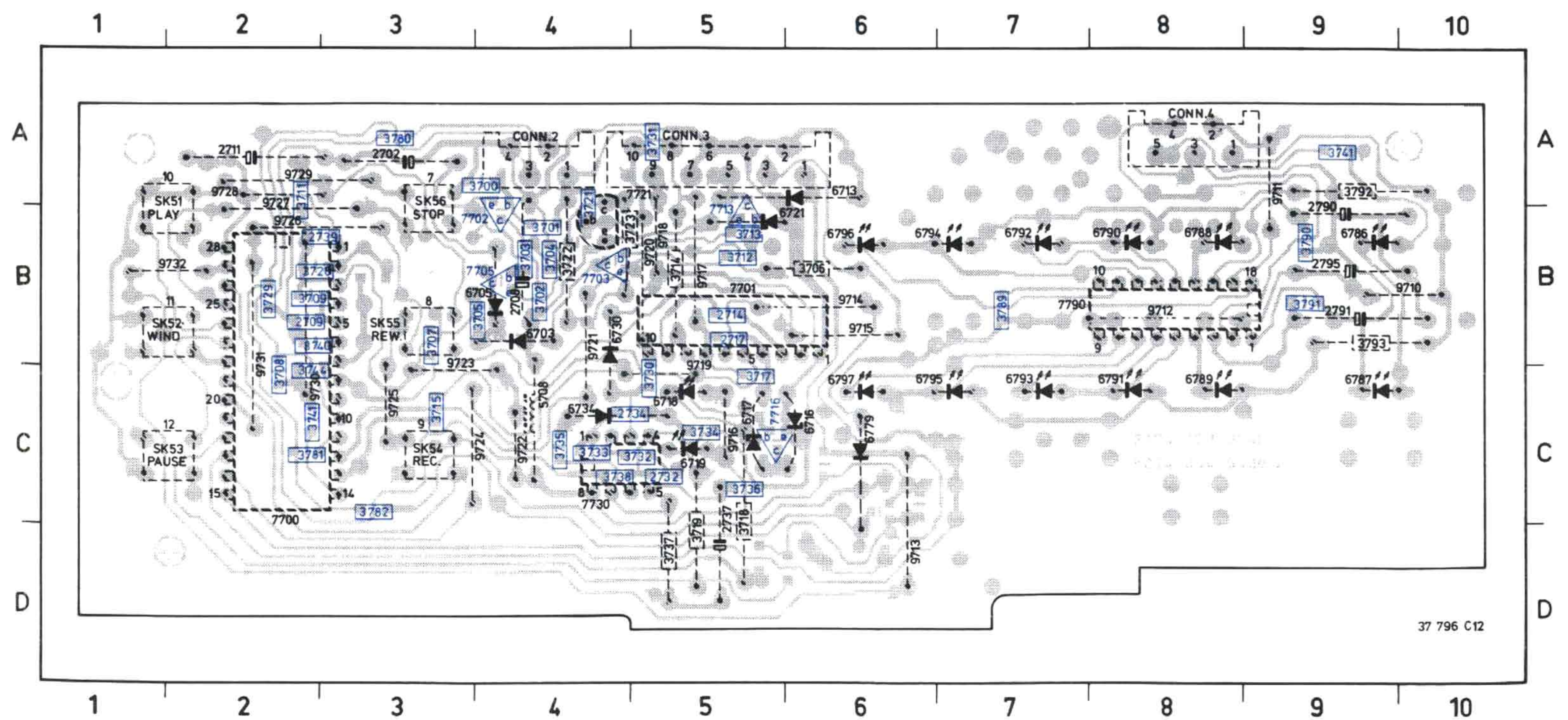
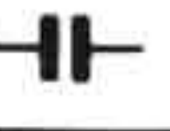
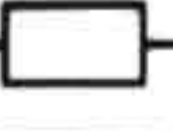
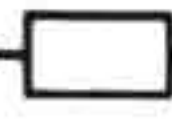
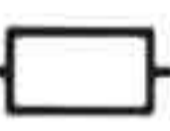

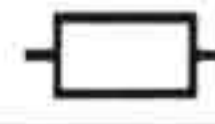



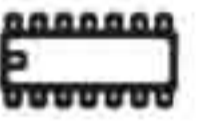

Fig. 15

©  Chips 50 V NP0 S1206			©  Chips 0,125 W S1206			©  Chips 0,125 W S1206		
1 pF	5%	4822 122 32279	9,1 E	5%	4822 111 90398	9,1 k	2%	4822 111 90373
1,5 pF	5%	4822 122 31792	10 E	2%	5322 111 90095	10 k	2%	4822 111 90249
1,8 pF	5%	4822 122 32087	11 E	2%	4822 111 90338	11 k	2%	4822 111 90337
3,3 pF	5%	4822 122 32079	12 E	2%	4822 111 90341	12 k	2%	4822 111 90253
3,9 pF	5%	4822 122 32081	13 E	2%	4822 111 90343	13 k	2%	4822 111 90509
4,7 pF	5%	4822 122 32082	15 E	2%	4822 111 90344	15 k	2%	4822 111 90196
8,2 pF	5%	4822 122 32083	16 E	2%	4822 111 90347	16 k	2%	4822 111 90346
10 pF	5%	4822 122 31971	18 E	2%	5322 111 90139	18 k	2%	4822 111 90238
12 pF	5%	4822 122 32139	20 E	2%	4822 111 90352	20 k	2%	4822 111 90349
18 pF	5%	4822 122 31769	22 E	2%	4822 111 90186	22 k	2%	4822 111 90251
22 pF	10%	4822 122 31837	24 E	2%	4822 111 90355	24 k	2%	4822 111 90512
27 pF	5%	4822 122 31966	27 E	2%	5322 111 90375	27 k	2%	4822 111 90542
33 pF	5%	4822 122 31756	30 E	2%	4822 111 90356	30 k	2%	4822 111 90216
39 pF	5%	4822 122 31972	33 E	2%	4822 111 90357	33 k	2%	5322 111 90267
47 pF	5%	4822 122 31772	36 E	2%	4822 111 90359	36 k	2%	4822 111 90514
56 pF	5%	4822 122 31774	39 E	2%	4822 111 90361	39 k	2%	5322 111 90108
68 pF	5%	4822 122 32267	43 E	2%	5322 116 90125	43 k	2%	4822 111 90363
82 pF	10%	4822 122 31839	47 E	2%	4822 111 90217	47 k	2%	4822 111 90543
100 pF	5%	4822 122 31765	51 E	2%	4822 111 90365	51 k	2%	5322 111 90274
120 pF	5%	4822 122 31766	56 E	2%	4822 111 90239	56 k	2%	4822 111 90573
150 pF	5%	4822 122 31767	62 E	2%	4822 111 90367	62 k	2%	5322 111 90275
180 pF	2%	4822 122 31794	68 E	2%	4822 111 90203	68 k	2%	4822 111 90202
220 pF	5%	4822 122 31965	75 E	2%	4822 111 90371	75 k	2%	4822 111 90574
270 pF	5%	4822 122 32142	82 E	2%	4822 111 90124	82 k	2%	4822 111 90575
330 pF	10%	4822 122 31642	91 E	2%	4822 111 90375	91 k	2%	5322 111 90277
390 pF	5%	4822 122 31771	100 E	2%	5322 111 90091	100 k	2%	4822 111 90214
470 pF	5%	4822 122 31727	110 E	2%	4822 111 90335	110 k	2%	5322 111 90269
560 pF	5%	4822 122 31773	120 E	2%	4822 111 90339	120 k	2%	4822 111 90568
680 pF	5%	4822 122 31775	130 E	2%	4822 111 90164	130 k	2%	4822 111 90511
820 pF	5%	4822 122 31974	150 E	2%	5322 111 90098	150 k	2%	5322 111 90099
1 nF	10%	5322 122 31647	160 E	2%	4822 111 90345	160 k	2%	5322 111 90264
1,2 nF	5%	4822 122 31807	180 E	2%	5322 111 90242	180 k	2%	4822 111 90565
1,5 nF	10%	4822 122 31781	200 E	2%	4822 111 90348	200 k	2%	4822 111 90351
2,2 nF	10%	4822 122 31644	220 E	2%	4822 111 90178	220 k	2%	4822 111 90197
2,7 nF	10%	4822 122 31783	240 E	2%	4822 111 90353	240 k	2%	4822 111 90215
3,3 nF	10%	4822 122 31969	270 E	2%	4822 111 90154	270 k	2%	4822 111 90302
4,7 nF	10%	4822 122 31784	300 E	2%	4822 111 90156	300 k	2%	5322 111 90266
5,6 nF	10%	4822 122 31916	330 E	2%	5322 111 90106	330 k	2%	4822 111 90513
6,8 nF	10%	4822 122 31976	360 E	1%	4822 111 90288	360 k	2%	4822 111 90515
10 nF	10%	4822 122 31728	360 E	2%	4822 111 90358	390 k	2%	4822 111 90182
12 nF	10%	5322 122 31648	390 E	2%	5322 111 90138	430 k	2%	4822 111 90168
15 nF	10%	4822 122 31782	430 E	2%	4822 111 90362	470 k	2%	4822 111 90161
18 nF	10%	4822 122 31759	470 E	2%	5322 111 90109	510 k	2%	4822 111 90364
22 nF	10%	4822 122 31797	510 E	2%	4822 111 90245	560 k	2%	4822 111 90169
33 nF	10%	4822 122 31981	560 E	2%	5322 111 90113	620 k	2%	4822 111 90213
100 nF	20%	4822 122 31947	620 E	2%	4822 111 90366	680 k	2%	4822 111 90368
			680 E	2%	4822 111 90162	750 k	2%	4822 111 90369
			750 E	2%	5322 111 90306	820 k	2%	4822 111 90205
			820 E	2%	4822 111 90171	910 k	2%	4822 111 90374
			910 E	2%	4822 111 90372	1 M	2%	4822 111 90252
			1 k	2%	5322 111 90092	1,1 M	5%	4822 111 90408
			1,1 k	2%	4822 111 90336	1,2 M	5%	4822 111 90409
			1,2 k	2%	5322 111 90096	1,3 M	5%	4822 111 90411
			1,3 k	2%	4822 111 90244	1,5 M	5%	4822 111 90412
			1,5 k	2%	4822 111 90151	1,6 M	5%	4822 111 90413
			1,6 k	2%	5322 111 90265	1,8 M	5%	4822 111 90414
			1,8 k	2%	5322 111 90101	2 M	5%	4822 111 90415
			2 k	2%	4822 111 90165	2,2 M	5%	4822 111 90185
			2,2 k	2%	4822 111 90248	2,4 M	5%	4822 111 90416
			2,4 k	2%	4822 111 90289	2,7 M	5%	4822 111 90417
			2,7 k	2%	4822 111 90569	3 M	5%	4822 111 90418
			3 k	2%	4822 111 90198	3,3 M	5%	4822 111 90191
			3,3 k	2%	4822 111 90157	3,6 M	5%	4822 111 90419
			3,6 k	2%	5322 111 90107	3,9 M	5%	4822 111 90421
			3,9 k	2%	4822 111 90571	4,3 M	5%	4822 111 90422
			4,3 k	2%	4822 111 90167	4,7 M	5%	4822 111 90423
			4,7 k	2%	5322 111 90111	5,1 M	5%	4822 111 90424
			5,1 k	2%	5322 111 90268	5,6 M	5%	4822 111 90425
			5,6 k	2%	4822 111 90572	6,2 M	5%	4822 111 90426
			6,2 k	2%	4822 111 90545	6,8 M	5%	4822 111 90235
			6,8 k	2%	4822 111 90544	7,5 M	5%	4822 111 90427
			7,5 k	2%	4822 111 90276	8,2 M	5%	4822 111 90237
			8,2 k	2%	5322 111 90118	9,1 M	5%	4822 111 90428
©  Chips 0,125 W S1206								
0 E	jumper	4822 111 90163						
1 E	5%	4822 111 90184						
1,1 E	5%	4822 111 90377						
1,2 E	5%	4822 111 90378						
1,3 E	5%	4822 111 90379						
1,5 E	5%	4822 111 90381						
1,6 E	5%	4822 111 90382						
1,8 E	5%	4822 111 90383						
2 E	5%	4822 111 90384						
2,2 E	5%	5322 111 90104						
2,4 E	5%	4822 111 90385						
2,7 E	5%	4822 111 90386						
3 E	5%	4822 111 90387						
3,3 E	5%	4822 111 90338						
3,6 E	5%	4822 111 90389						
3,9 E	5%	4822 111 90391						
4,3 E	5%	4822 111 90392						
4,7 E	5%	5322 111 90376						
5,1 E	5%	4822 111 90393						
5,6 E	5%	4822 111 90394						
6,2 E	5%	4822 111 90395						
6,8 E	5%	4822 111 90254						
7,5 E	5%	4822 111 90396						
8,2 E	5%	4822 111 90397						

	
HZ12A1 14V 4822 130 32832 HZ20-2 20V 4822 130 31467 HZ2C2 2V4 4822 130 32861 HZ3C2 3V3 4822 130 32565 HZ6A3 5V6 4822 130 32697 HZ7C2 7V5 4822 130 32862 Led TLG123A Green 5322 130 34959 Led TLR123 Red 5322 130 34957 1N4002 5322 130 30684 1N4148 4822 130 30621	3108 Potm. 10k 20% lin 4822 100 10871 3109 Potm. 10k 20% lin 4822 100 10871 3140 Potm. slide 50k log 4822 105 10644 3194 Metal film 3k3 1% 0,6 W 4822 116 53105 3195 Metal film 3k3 1% 0,6 W 4822 116 53105 3264 Potm. 10k 20% lin 4822 100 10871 3265 Potm. 10k 20% lin 4822 100 10871 3266 Potm. 47k 20% lin 4822 100 10872 3267 Potm. 47k 20% lin 4822 100 10872 3714 Safety res. 22E 2% 4822 111 30847
	
BC548B 4822 130 40937 BC808-40R 4822 130 42617 BC817-40 4822 130 42615 BC817-40R 4822 130 41618 BC818-40 4822 130 41616 BC848B 5322 130 41982 BC848BR 4822 130 42549 BC848C 5322 130 42136 BC849C 4822 130 42614 BC858B 5322 130 41983 BC858BR* 4822 130 42134	2106 Cap. ceramic 33nF 10% 63 V 5322 122 31848 2107 Cap. ceramic 33nF 10% 63 V 5322 122 31848 2148 Cap. foil 4,7nF 1% 63 V 4822 121 50539 2149 Cap. foil 4,7nF 1% 63 V 4822 121 50539 2150 Cap. foil 33nF 1% 63 V 5322 121 54111 2151 Cap. foil 33nF 1% 63 V 5322 121 54111
	
	5100 Coil 36 mH 4822 156 21061 5101 Coil 36 mH 4822 156 21061 5103 Coil 3,3 mH 4822 152 20544 5106 Filter 19 kHz 4822 158 60532 5107 Filter 19 kHz 4822 158 60532 5708 Coil 470µH 4822 157 51193
	Miscellaneous
AN6888 Led driver 4822 209 83146 BA6109 4822 209 82059 LM1121CN 4822 209 81621 LM358N 4822 209 81472 MC6804P2P/SC94005 (SE2) 4822 209 82111 MC6804P2P/SC94006 (SE3) 4822 209 11051 MJM4558D 4822 209 80401 TDA1522 4822 209 81178	BU-0 Mains socket 4822 265 20265 BU-2 Microphone socket 4822 267 30638 BU4-7 Cinch socket 4822 267 40586 BU-8 Headphone socket 4822 267 30568 SK-0 Power switch 4822 276 11036 SK-1 Rec. slide switch 4822 277 30722 SK2-5 Switch assy 4822 276 40342 SK51 Play switch 4822 276 11276 SK52 Wind switch 4822 276 11276 SK53 Pause switch 4822 276 11276 SK54 Rec. switch 4822 276 11276 SK55 Rewind switch 4822 276 11276 SK56 Stop switch 4822 276 11276 5500 Mains transformer 4822 146 21049

GB

Safety regulations require that the set be restored to its original condition and that parts which are identical with those specified be used.

D

Bei jeder Reparatur sind die geltenden Sicherheitsvorschriften zu beachten. Der Originalzustand des Geräts darf nicht verändert werden; für Reparaturen sind Original-Ersatzteile zu verwenden.

NL

Veiligheidsbepalingen vereisen, dat het apparaat in zijn oorspronkelijke toestand wordt teruggebracht en dat onderdelen, identiek aan de gespecificeerde, worden toegepast.

I

Le norme di sicurezza esigono che l'apparecchio venga rimesso nelle condizioni originali e che siano utilizzati i pezzi di ricambio identici a quelli specificati.

F

Les normes de sécurité exigent que l'appareil soit remis à l'état d'origine et que soient utilisées les pièces de rechange identiques à celles spécifiées.